

P-A

Pilona modelo Parking abatible.

Revision: 01 - 29/12/2021

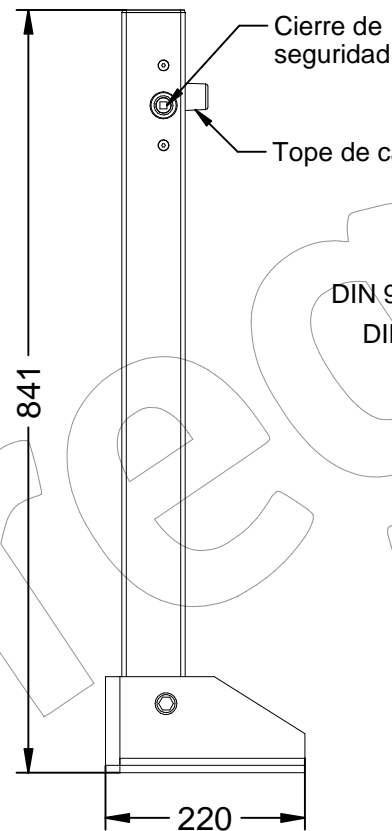
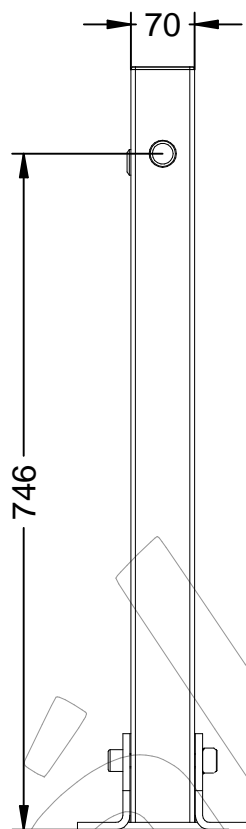
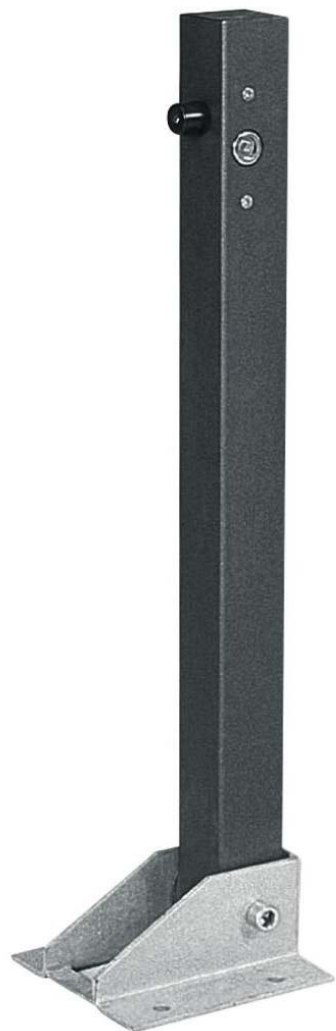

DIN 933 M10x70

DIN 9021 M10

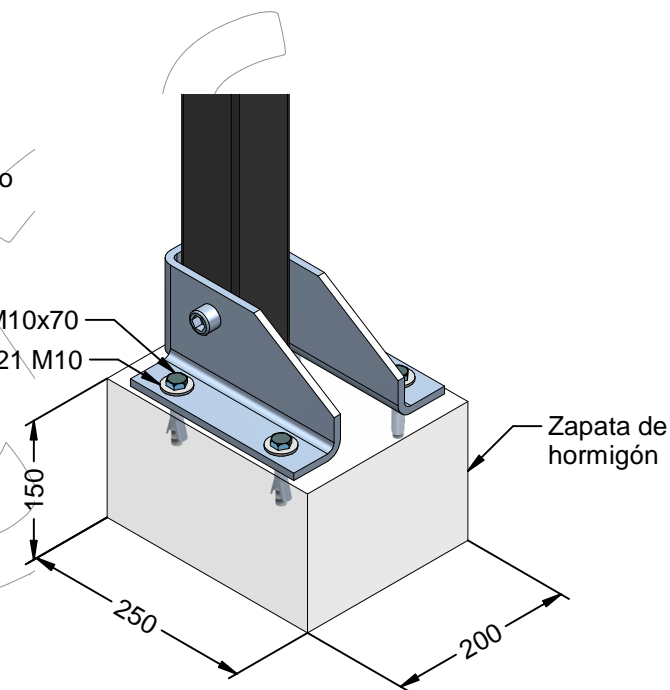

Detalle anclaje

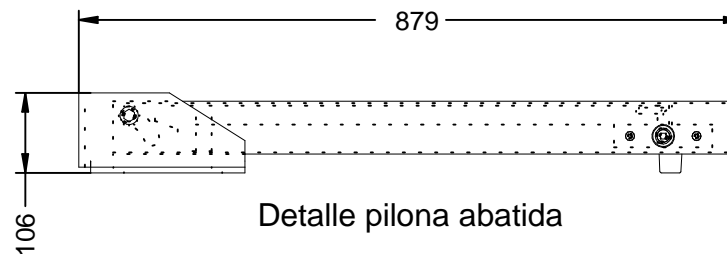
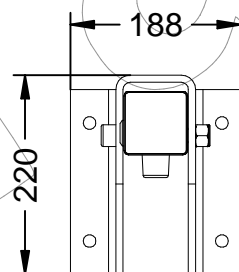

P-A

Pilona modelo Parking abatible.

Revision: 01 - 29/12/2021

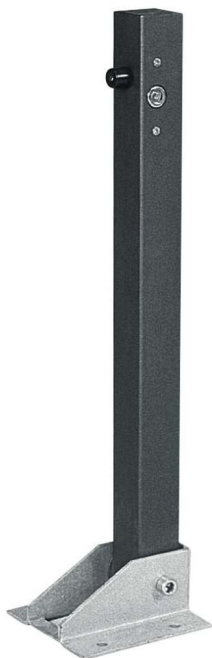

-ES-



Descripción: Pilona modelo Parking abatible.

Material: Acero.

Acabado:

Cuerpo: Pintado epoxi al horno.

Base: Galvanizado.

Embalaje: Paletizado y plastificado.

Tipo de llave: Cuadradillo de 8 mm.

Anclaje: Mediante 4 tornillos (No suministrados).

-EN-



Description: Folding Parking bollard model.

Material: Steel.

Paint finish:

Body: Baked epoxy painted.

Base: Galvanized.

Packaging: Palletized and laminated.

Key type: 8mm square drive.

Anchoring: By 4 screws (Not supplied).

-PT-



Descrição: Modelo com poste de amarração dobrável.

Material: Aço.

Terminar:

Corpo: Cozido em pintura epóxi.

Base: Galvanizada.

Embalagem: Paletizada e laminada.

Tipo de chave: Unidade quadrada de 8 mm.

Ancoragem: Por 4 parafusos (não fornecidos).

-CA-



Descripció: Pilona model Parking abatible.

Material: Acer.

Acabat:

Cos: Pintat epoxi al forn.

Base: Galvanitzat.

Embalatge: Paletitzat i plastificat.

Tipus de clau: Quadrat de 8 mm.

Anclatge: Mitjançant 4 cargols (No subministrats).

-FR-



Description: Modèle de borne de stationnement pliable.

Matériel: Acier.

Finir:

Corps: Peinture époxy cuite au four.

Base: Galvanisé.

Conditionnement: Palettisé et plastifié.

Type de clé: Carré de 8 mm.

Ancrage: Par 4 vis (Non fournies).