

NR-2-400-FLAT

Conjunto de 4 tapas NR clase D400, en fundición dúctil y sin inscripción anonima - FLAT -

Revision: 01 - 14/10/2022

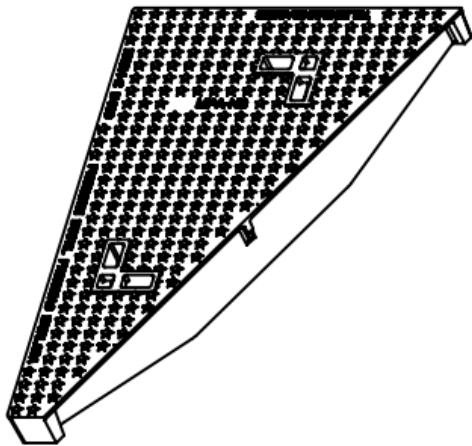
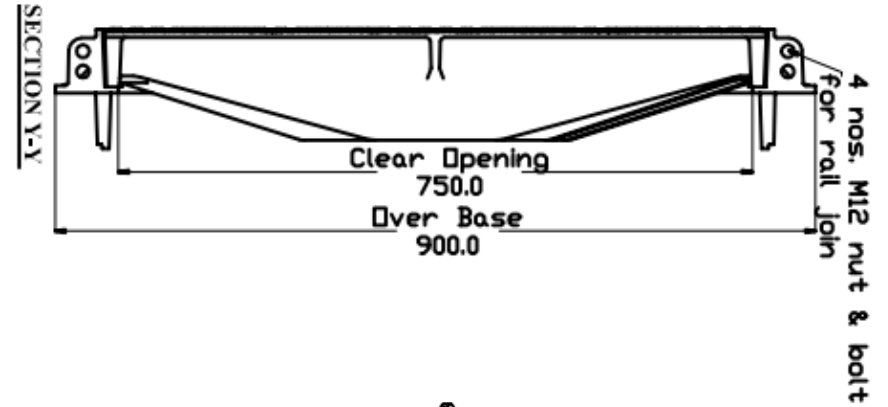
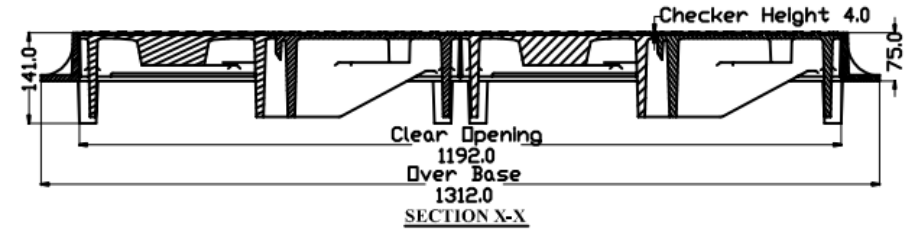
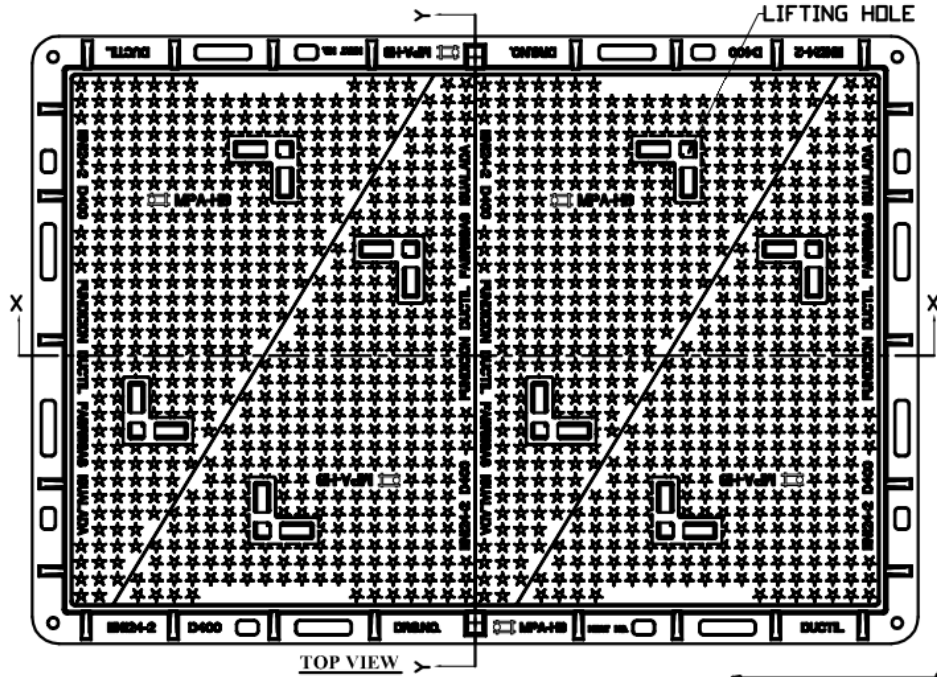

COVER PART

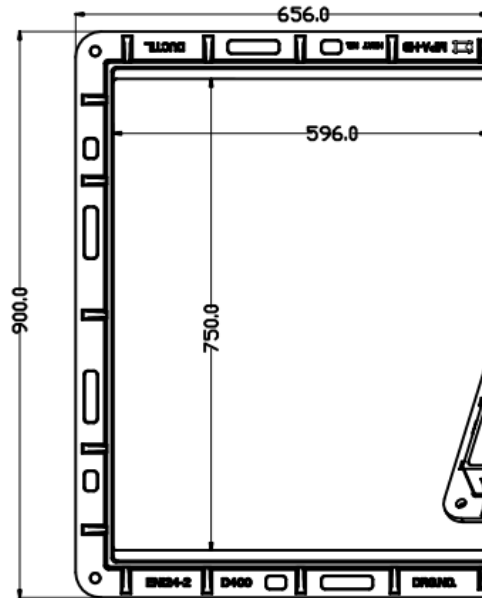

FRAME PART

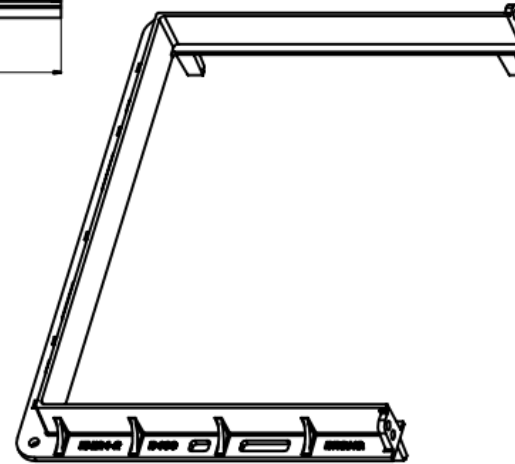

FRAME PART

NR-2-400-FLAT

Conjunto de 4 tapas NR clase D400, en fundición dúctil y sin inscripción anonima - FLAT -

Revision: 01 - 14/10/2022

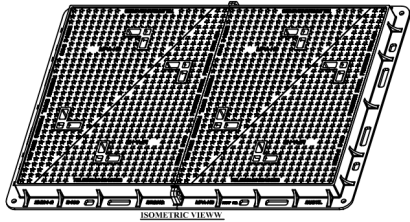

-ES- 

Descripción: Conjunto de 4 tapas NR clase D400, en fundición dúctil, de medidas generales 1320x900x75 mm y paso libre de 1192x750 mm, sin inscripción, anonima.

Material: Fundición Dúctil EN-GJS-500-7.

Acabado: Pintado negro asfáltico.

Norma: EN 124-2.

Clase: D 400.

Embalaje: Paletizado y plastificado.

-EN- 

Description: Set of 4 caps NR class D400, in cast iron ductile, with general measures 1320x900x75 mm and free passage of 1192x750 mm, without inscription, anonymous.

Material: Ductile Iron EN-GJS-500-7.

Paint finish: Painted black asphalt.

Standard: EN 124-2.

Class: D400.

Packaging: Palletized and plasticized.

-PT- 

Descrição: Conjunto de 4 tampas NR classe D400, em ferro fundido dúctil, com medidas gerais 1320x900x75 mm e passagem livre de 1192x750 mm, sem inscrição, anónimo.

Material: Ferro dúctil EN-GJS-500-7.

Acabamento: Asfalto pintado de preto.

Padrão: EN 124-2.

Classe: D400.

Embalagem: Paletizada e plastificada.

-CA- 

Descripció: Conjunt de 4 tapes NR classe D400, en fosa dúctil, de mides generals 1320x900x75 mm i pas lliure de 1192x750 mm, sense inscripció, anònima.

Material: Foneria Dúctil EN-GJS-500-7.

Acabat: Pintat negre asfàltic.

Norma: EN 124-2.

Classe: D 400.

Embalatge: Paletitzat i plastificat.

-FR- 

Description: Jeu de 4 bouchons NR classe D400, en fonte ductile, avec des mesures générales 1320x900x75 mm et passage libre de 1192x750 mm, sans inscription, anonyme.

Matériau: Fonte ductile EN-GJS-500-7.

Finition: Asphalte peint en noir.

Norme: EN 124-2.

Classe: D400.

Conditionnement: Palettisé et plastifié.