

I-100
Alcorque modelo Excéntrico

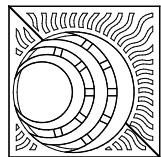

exterior 0°
interior 0°

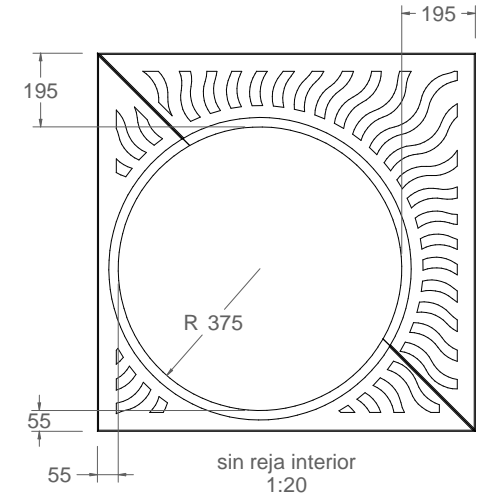
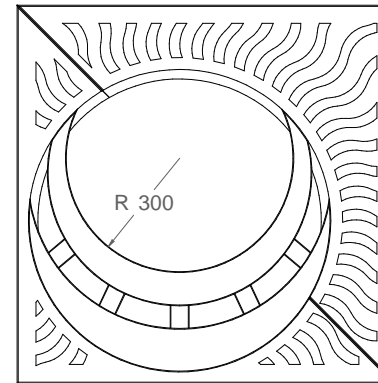
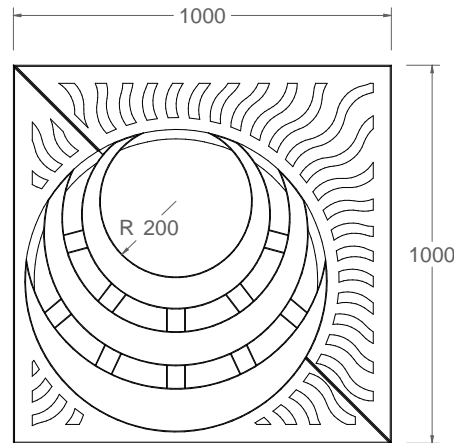
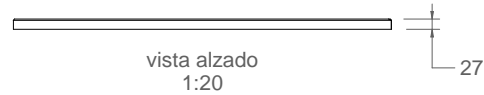
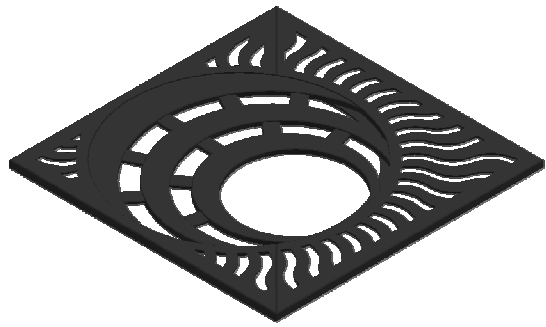
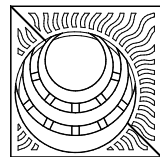

exterior 0°
interior 90°

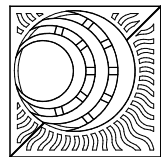

exterior 90°
interior 0°

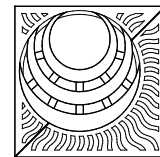

exterior 90°
interior 90°

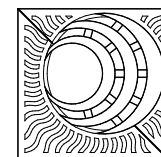

exterior 180°
interior 0°

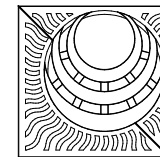

exterior 180°
interior 90°

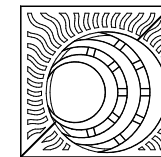

exterior 270°
interior 0°

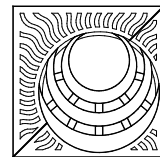

exterior 270°
interior 90°

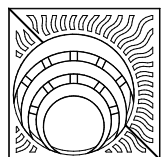

exterior 0°
interior 180°

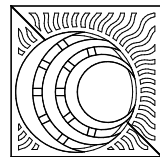

exterior 0°
interior 270°

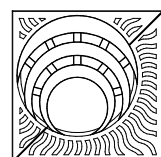

exterior 90°
interior 180°

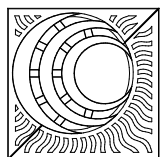

exterior 90°
interior 270°

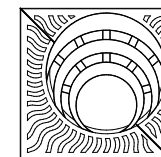

exterior 180°
interior 180°

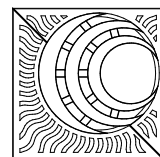

exterior 180°
interior 270°

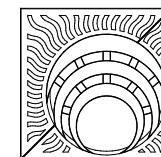

exterior 270°
interior 180°

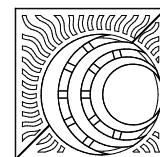

exterior 270°
interior 270°

Material: Hierro, fundición gris tipo 20
Peso: 47.035 kg
Acabado: Pintado oxirón
Embalaje: Paletizado y plastificado

