

E-30X30-HONDAS

Tapa y marco de arqueta hidráulica rellenable.

Revision: 01 - 23/08/2018

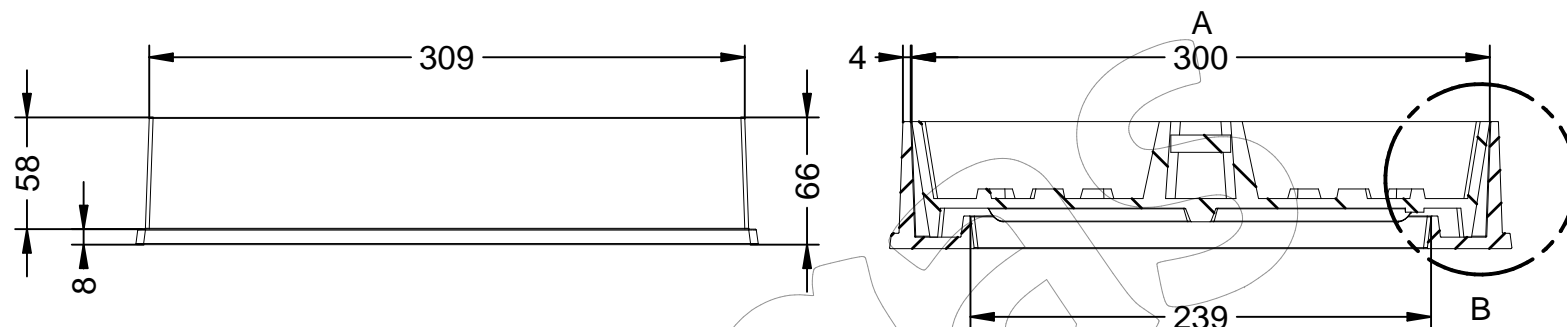
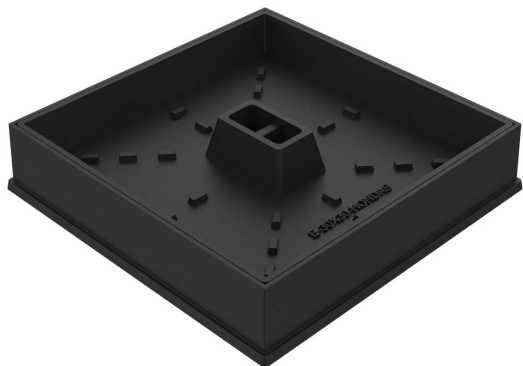

40 mm de profundidad para rellenar.

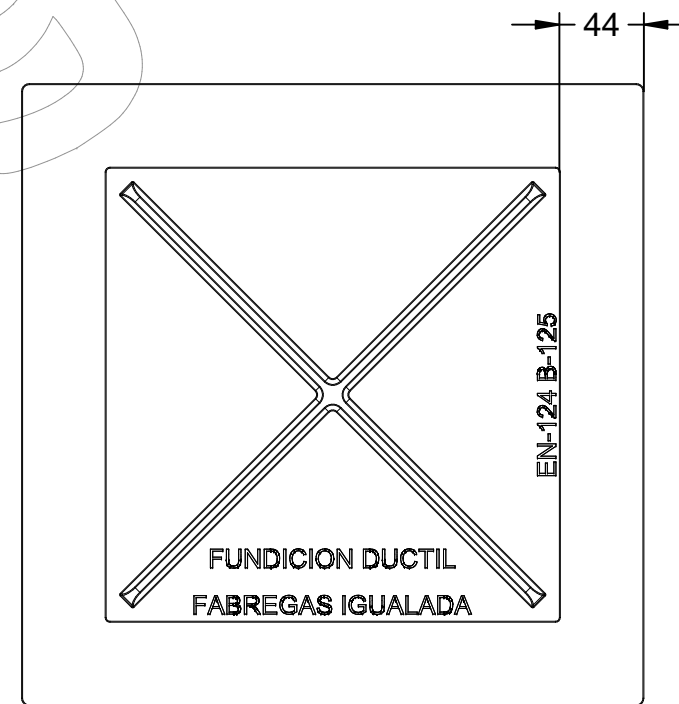
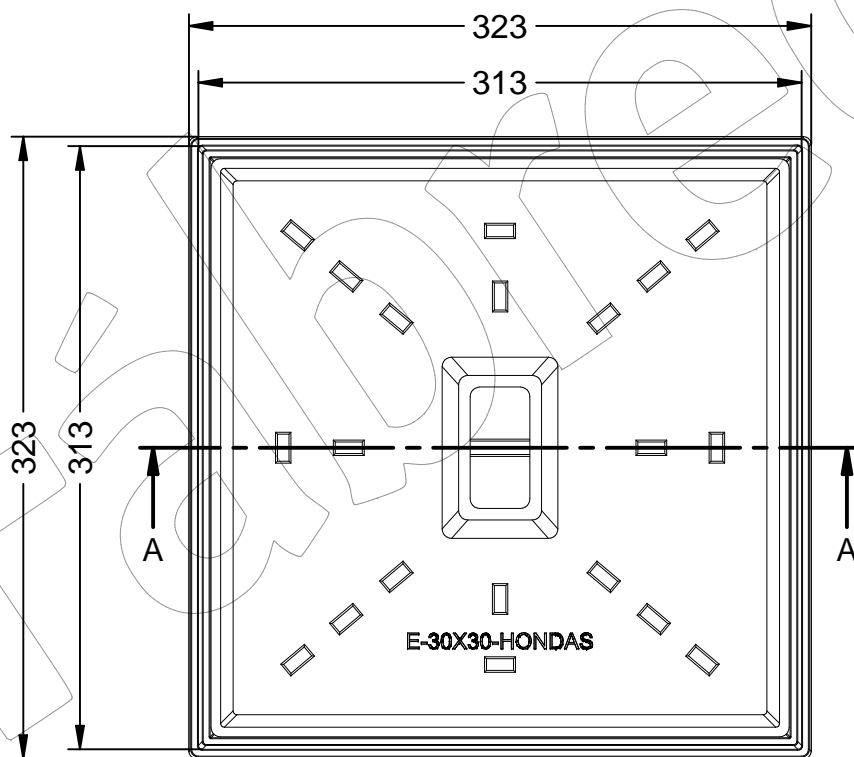
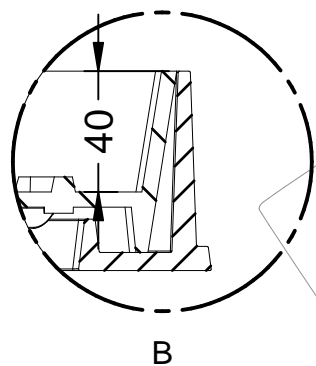

E-30X30-HONDAS

Tapa y marco de arqueta hidráulica rellenable.

Revision: 01 - 23/08/2018

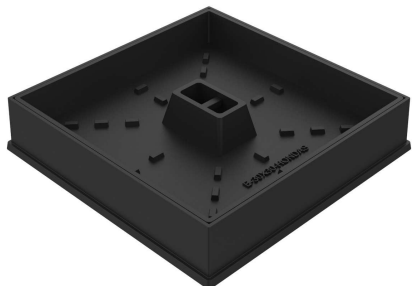

-ES- 

Descripción: Tapa y marco de arqueta hidráulica rellenable.

Material: Fundición Dúctil EN-GJS-500-7.

Acabado: Pintado negro asfáltico.

Norma: UNE-EN 124.

Clase: B-125.

Embalaje: Paletizado y plastificado.

-EN- 

Description: Top and frame of refillable hydraulic box.

Material: Ductile cast iron EN-GJS-500-7.

Paint finish: Painted black asphalt.

Standard: UNE-EN 124.

Class: B-125.

Packing: Palletizing and plasticized.

-PT- 

Descrição: Topo e estrutura da caixa hidráulica recarregável.

Material: Ferro fundido dúctil EN-GJS-500-7.

Acabamento: Pintado asfalto preto.

Regra: UNE-EN 124.

Classe: B-125.

Embalagem: Paletização e plastificado.

-CA- 

Descripció: Tapa i marc d'arqueta hidràulica emplenable.

Material: Fosa Dúctil EN-GJS-500-7.

Acabat: Pintat negre asfàltic.

Norma: UNE-EN 124.

Classe: B-125.

Embalatge: Paletitzat i plastificat.

-FR- 

Description: Dessus et cadre du boîtier hydraulique rechargeable.

Matériel: Fer EN-GJS-500-7 ductiles.

Finition: Painted asphalte noir.

Règle: UNE-EN 124.

Classe: B-125.

Emballage: Palettisation et plastifié.