

ISO 9001
BUREAU VERITAS
Certification

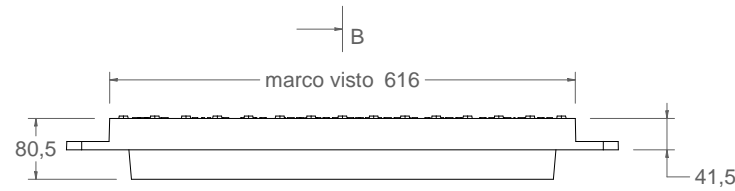

D-98

Reja y marco imbornal modelo Oporto

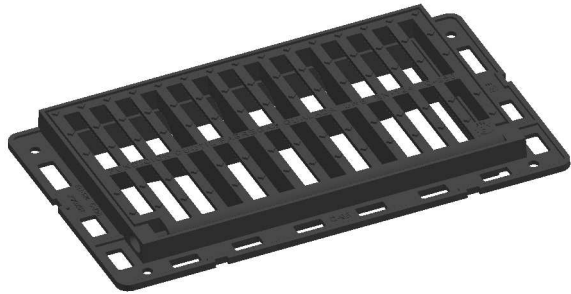

vista alzado
1:10

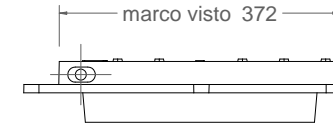

vista lateral
1:10

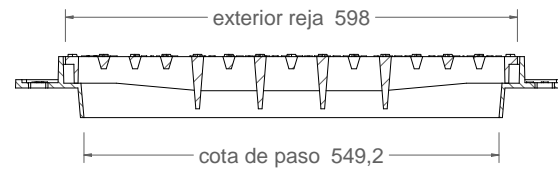

Corte A-A
1:10

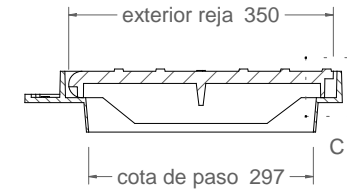

Corte B-B
1:10

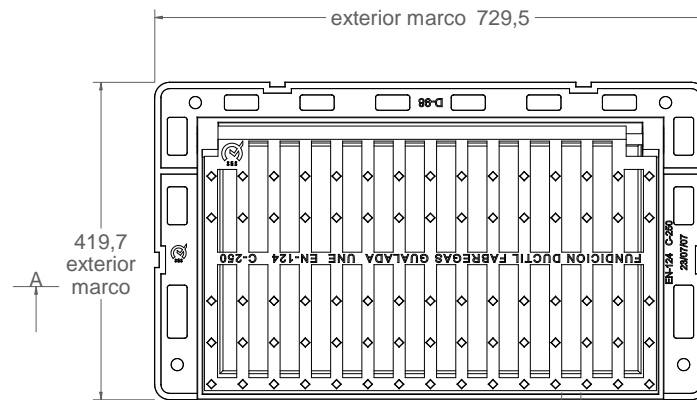

vista en planta
1:10

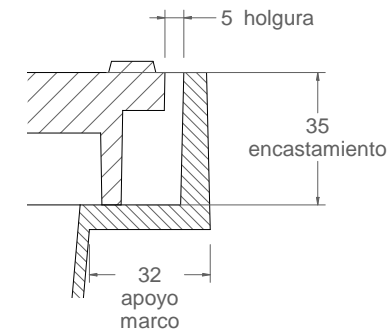

Detalle C

Material: Fundicion ductil GGG40
Peso: 27.267 kg
Acabado: Pintado negro asfáltico
Norma: UNE EN-124
Clase: C-250
Superficie de absorción: 1024.16 cm²