

D-16-D400

Tapa y marco de arqueta hidráulica.

Revision: 01 - 22/11/2017

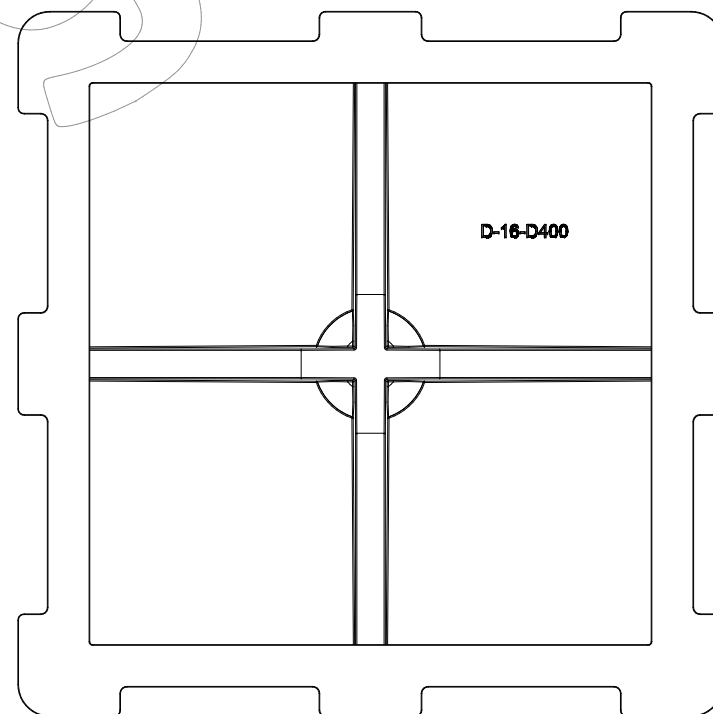
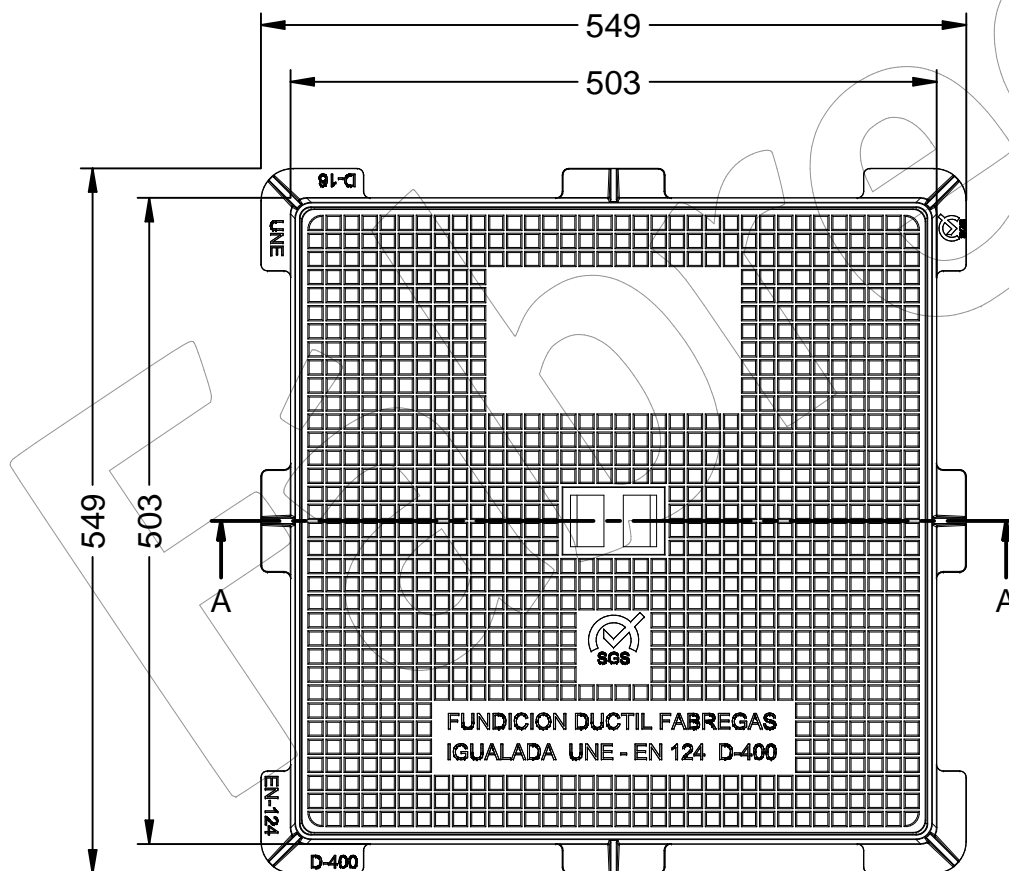
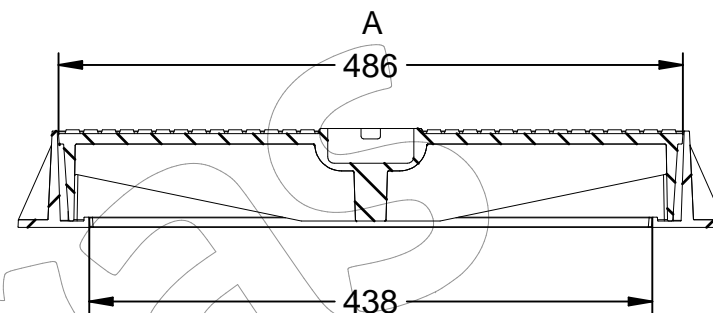
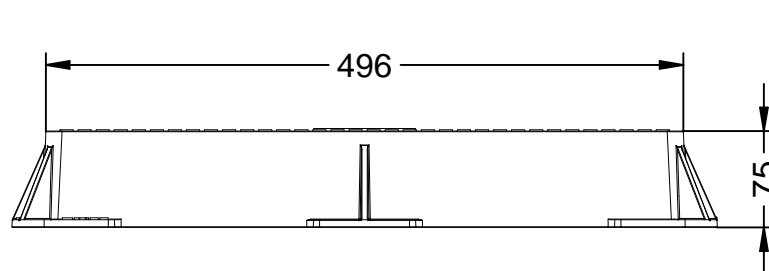
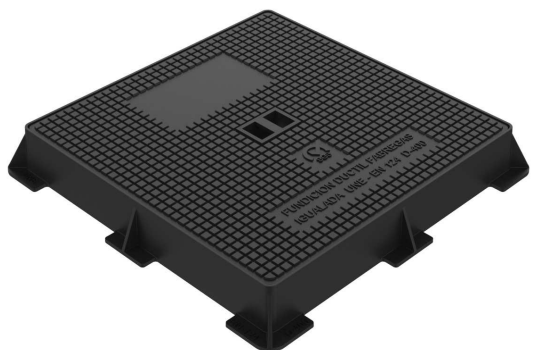

D-16-D400

Tapa y marco de arqueta hidráulica.

Revision: 01 - 22/11/2017

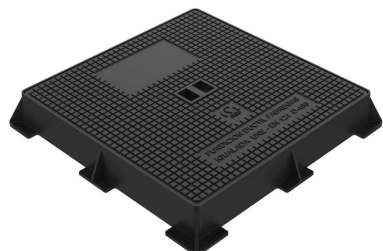

-ES- 

Descripción: Tapa y marco de arqueta hidráulica.

Material: Fundición Dúctil EN-GJS-500-7.

Acabado: Pintado negro asfáltico.

Norma: UNE-EN 124.

Clase: D-400.

Embalaje: Paletizado y plastificado.

-EN- 

Description: Cover and frame of hydraulic chest.

Material: Ductile cast iron EN-GJS-500-7.

Paint finish: Painted black asphalt.

Standard: UNE-EN 124.

Class: D-400.

Packing: Palletizing and plasticized.

-PT- 

Descrição: A tampa e a caixa de válvula hidráulica quadro.

Material: Ferro fundido dúctil EN-GJS-500-7.

Acabamento: Pintado asfalto preto.

Regra: UNE-EN 124.

Classe: D-400.

Embalagem: Paletização e plastificado.

-CA- 

Descripció: Tapa i marc d'arqueta hidràulica.

Material: Fosa Dúctil EN-GJS-500-7.

Acabat: Pintat negre asfàltic.

Norma: UNE-EN 124.

Classe: D-400.

Embalatge: Paletitzat i plastificat.

-FR- 

Description: Couvercle et boîte de valve hydraulique de cadre.

Matériel: Fer EN-GJS-500-7 ductiles.

Finition: Painted asphalte noir.

Règle: UNE-EN 124.

Classe: D-400.

Emballage: Palettisation et plastifié.