







# C-430-TPU-PLUS

Pilona tipo Barcelona, de Poliuretano, para empotrar, para atornillar en aro o con base extraíble, con dos argollas reflectantes.  
Dimensiones: Ø100 x 1096 mm (Disponible en varios colores).



## Colores disponibles:

-  Gris forja RAL 7024 (RAL aproximado)
-  Rojo RAL 3020
-  **Amarillo RAL 1021**
-  Verde RAL 6029
-  Azul RAL 5005
-  Granate RAL 3011



➡ Imagen - C-430-TPU-PLUS-AMA (Color Amarillo RAL 1021)

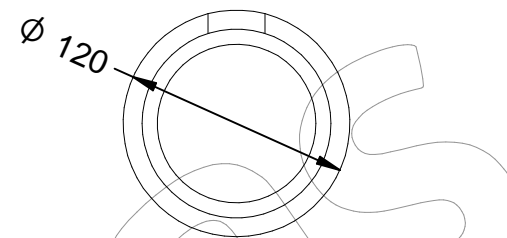
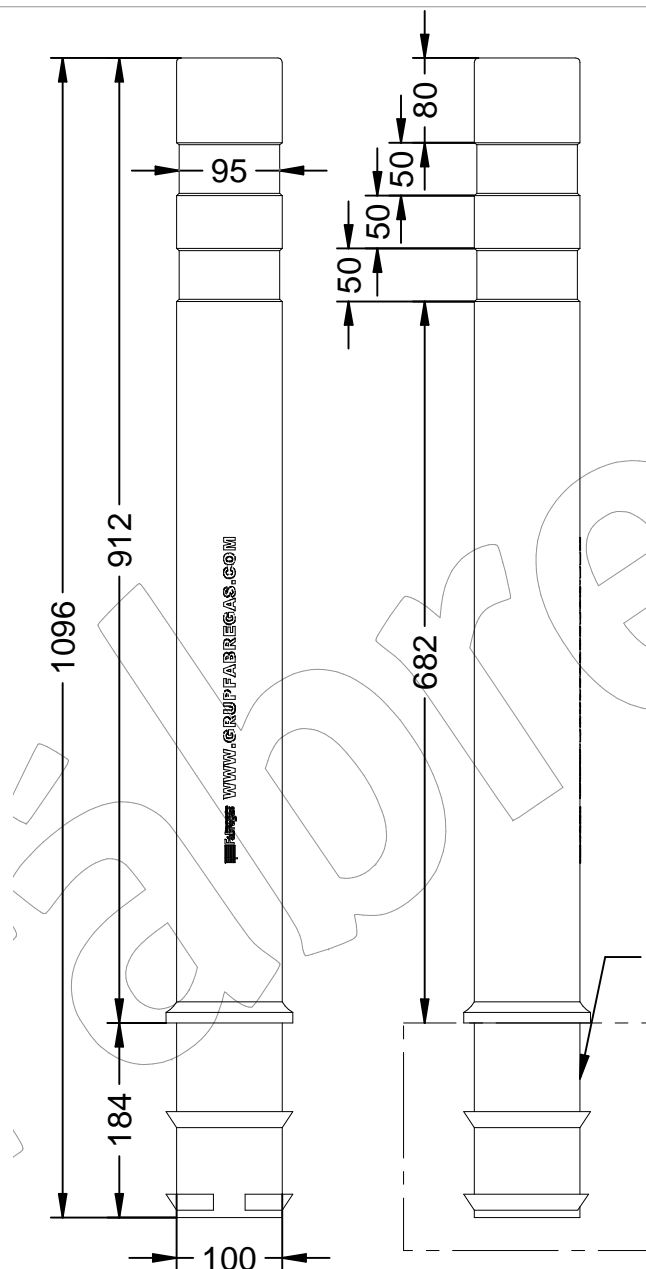

### Metodo para fijar la pilona al suelo:

Por empotramiento, para fijar al suelo con aro o con base extraíble (No incluidos).

Altura útil después de la instalación: 912 mm.  
Alçada útil després de la instal·lació: 912 mm.  
Useful height after installation: 912 mm.

Zona a empotrar.  
Zona per a encasta  
Recessed area.

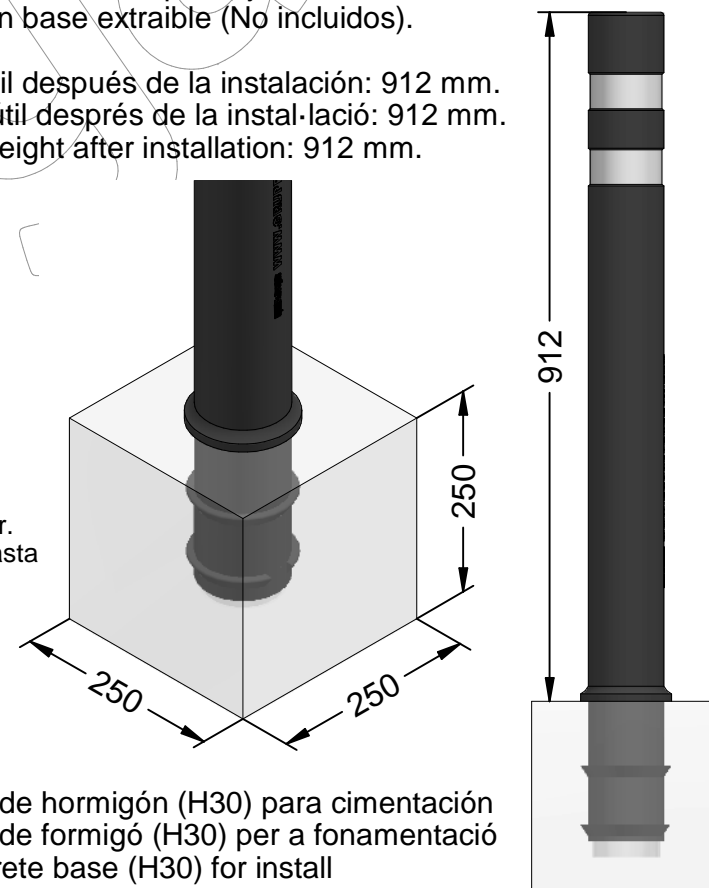

Base de hormigón (H30) para cimentación  
Base de formigó (H30) per a fonamentació  
Concrete base (H30) for install

# C-430-TPU-PLUS

Pilona tipo Barcelona, de Poliuretano, para empotrar, para atornillar en aro o con base extraíble, con dos argollas reflectantes.  
Dimensiones: Ø100 x 1096 mm (Disponible en varios colores).



Disponible en varios colores



Available in various colors



C-430-TPU-PLUS-ROJ  
( Rojo RAL 3020 )



C-430-TPU-PLUS-AZU  
( Azul RAL 5005 )



C-430-TPU-PLUS-GRIS  
( Gris forja RAL 7024 )  
- RAL APROXIMADO -

C-430-TPU-PLUS-AMA  
( Amarillo RAL 1021 )

C-430-TPU-PLUS-VER  
( Verde RAL 6029 )

C-430-TPU-PLUS-GRA  
( Granate RAL 3011 )

## C-430-TPU-PLUS

Pilona tipo Barcelona, de Poliuretano, para empotrar, para atornillar en aro o con base extraíble, con dos argollas reflectantes.  
Dimensiones: Ø100 x 1096 mm (Disponible en varios colores).

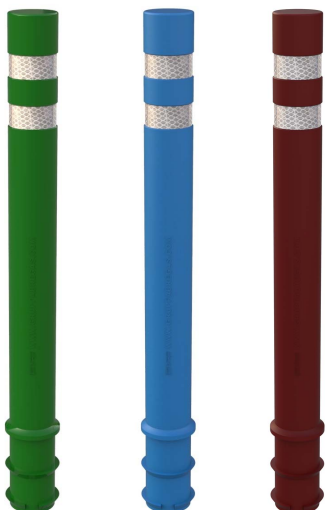

**-ES-** 

Descripción: Pilona tipo Barcelona, fabricada en poliuretano, de alto impacto, para empotrar, para atornillar en aro o con base extraíble.

Características:

Esta pilona recupera su verticalidad después de flexar al 90%.

Material: Poliuretano.

Dispone de dos argollas reflectantes.

No se oxida y no requiere mantenimiento.

Medidas: Tubo de Ø 100 mm x 1096 mm de altura.

Anclaje: Mediante empotramiento, para atornillar en aro o para fijar en base extraíble (No incluidos).

Colores disponibles:

Color gris forja RAL 7024.

(RAL Aproximado)

Color rojo RAL 3020.

Color amarillo RAL 1021.

Color verde RAL 6029.

Color azul RAL 5005.

Color granate RAL 3011.

**-CA-** 

Descripció: Pilona tipus Barcelona, fabricada en poliuretà, d'alt impacte.

Característiques:

Aquesta pilona recupera la seva verticalitat després de flexar al 90%.

Material: Poliuretà.

Disposa de dues argolles reflectores.

No s'oxida i no requereix manteniment.

Mides: Tub de Ø 100 mm x 1096 mm d'alçada.

Anclatge: Mitjançant encastament, per cargolar en cercol o per fixar en base extraíble (No inclosos).

Colors disponibles:

Color gris forja RAL 7024.

(RAL Aproximat)

Color vermell RAL 3020.

Color groc RAL 1021.

Color verd RAL 6029.

Color blau RAL 5005.

Color granat RAL 3011.

**-EN-** 

Description: Barcelona type bollard, made of polyurethane, high impact, for recessing, for screwing into a ring or with a removable base.

Characteristics:

This bollard recovers its verticality after to flex at 90%.

Material: Polyurethane.

It has two reflective rings.

It does not rust and requires no maintenance.

Measurements: Ø tube 100 mm x 1096 mm height.

Anchoring: By embedding, to screw into a ring or to fix on a removable base (Not included).

Available colours:

Forge gray color RAL 7024.

(Approximate RAL)

Red color RAL 3020.

Yellow color RAL 1021.

Green color RAL 6029.

Blue color RAL 5005.

Garnet color RAL 3011.

**-FR-** 

Description: Borne type Barcelona, en polyuréthane, haute à impact, à encastrer, à visser dans une bague ou avec socle amovible.

Caractéristiques:

Cette borne retrouve sa verticalité après pour fléchir à 90%.

Matériau: Polyuréthane.

Il possède deux anneaux réfléchissants.

Il ne rouille pas et ne nécessite aucun entretien.

Dimensions: Tube Ø 100 mm x 1096 mm de hauteur.

Ancrage: Par encastrement, à visser dans un anneau ou à fixer sur un socle amovible (Non inclus).

Couleurs disponibles:

Couleur gris forge RAL 7024.

(RAL approximatif)

Couleur rouge RAL 3020.

Couleur jaune RAL 1021.

Couleur vert RAL 6029.

Couleur bleu RAL 5005.

Couleur grenat RAL 3011.

**-PT-** 

Descrição: Dissuasor tipo Barcelona, fabricado em poliuretano, de alta impacto, para encastrar, para aparafusar em anel ou com base amovível.

Características:

Este poste recupera a sua verticalidade após flexionar em 90%.

Material: Poliuretano.

Possui dois anéis reflexivos.

Não enferruja e não requer manutenção.

Medidas: tubo Ø 100 mm x 1096 mm de altura.

Ancoragem: Por incorporação, para aparafusar em um anel ou para fixar em base removível (não incluída).

Cores disponiveis:

Forja cor cinza RAL 7024.

(RAL aproximado)

Cor vermelha RAL 3020.

Cor amarela RAL 1021.

Cor verde RAL 6029.

Cor azul RAL 5005.

Cor granada RAL 3011.