

100x100

Anillo de realce en hormigón H200 de $\phi 1000$ interior y 1070 mm de altura.

Revision: 01 - 30/12/2016

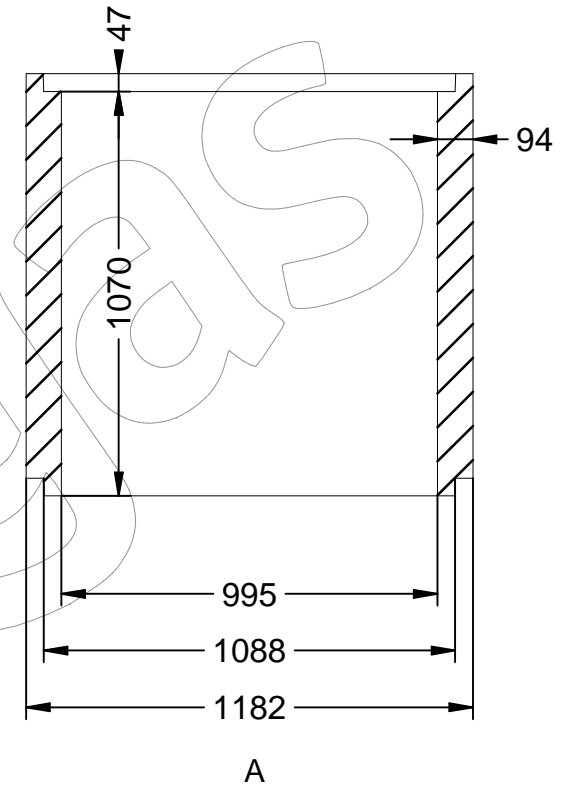
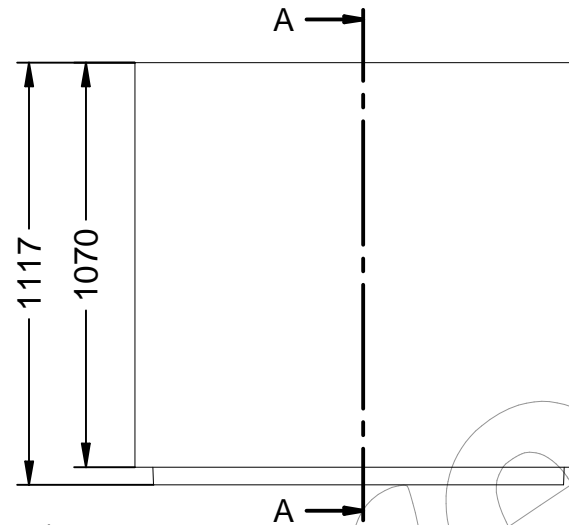

Material: Hormigón H-200.

